

WATERCO

Water, the Liquid of Life

Contact us:

Chainaris Phuket Engineering Co., Ltd.

63/13 Moo.2, T.Vichit, A.Muang Phuket 83000

Tel: 076-513100-3

Fax: 076-513105

Line: @chainaris, @chainarishop



Spa Equipment

Portable Spa Pool Systems

Warm jets and relaxing bubbles



Portapac's are centrifugal spa pool pumps with built-in electric heaters and electronic controls.

The Portapac circulates water through the spa jets as well as heating the water.

PORTABLE SPA POOL SYSTEMS

Part Number	Product Description	Nominal Size
45551403	Portapac Demand MK3 (10 amp)	Pump=1.0hp / Heater=1.6kW
45551413	Portapac Demand Elite MK3 (15 amp)	Pump=1.5hp / Heater=2.4kW

Spa side control units c/w touch pads

4555142	Portapac Demand SSC Air (10 amp)	Pump=1.0hp / Heater=1.6kW
4555143	Portapac Demand Elite SSC Air (15 amp)	Pump=1.5hp / Heater=2.4kW
4555144	Portapac Premium SSC Boost (10 amp)	Pump=1.0hp / Heater=1.6kW
4555146	Portapac Premium SSC Boost (15 amp)	Pump=1.5hp / Heater=2.4kW
4555148	Portapac Demand Elite SSC Boost (15 amp)	Pump=1.5hp / Heater=2.4kW
45551490	Portapac Demand SSC Boost (10 amp)	Pump=1.0hp / Heater=1.6kW

Specifications

Model	Unit Rated (Amps)	Pump (HP)	Motor (Amps)	Heater (Amps/kW)	No. of Jets	Heat Constant
Demand	10	1.0	3.6	6.7 / 1.6	4 - 6	4.4*
Demand Elite	15	1.5	4.8	10 / 2.4	6 - 8	2.9*
SSC Air 10A	10	1.0	3.6	6.7 / 1.6	4 - 6	4.4*
SSC Air 15A	15	1.5	4.8	10 / 2.4	6 - 8	2.9*
SSC Boost 10A	10	1.0	3.6	6.7 / 1.6	4 - 6	4.4*
SSC Boost 15A	15	1.5	4.8	10 / 2.4	6 - 8	2.9*
Premium SSC Boost 10A	10	1.0	3.6	6.7 / 1.6	4 - 6	4.4*
Premium SSC Boost 15A	15	1.5	4.8	10 / 2.4	6 - 8	2.9*

* Based on ideal heating with NO heat loss from the spa

Heat Constant is the time taken to heat 100 litres by 1°C - $Time = Heat\ Constant \times spa\ size\ in\ litres \times required\ temp\ rise / 100$

E.g. Time to heat a 1700lts spa by 5°C with an SSC Air 15A
 $Time = 2.9 \times 1700 \times 5 / 100$
 $= 246.5\ minutes$

Note : Actual time to heat may be longer than calculated. The use of a spa or solar blanket is highly recommended.

Model	Control	Pump	Demand	Air	Boost	Sanitiser Outlet	Light Outlet	Aux. Outlet
Demand	AS	✓	✓		✓			
Demand Elite	AS	✓	✓		✓			
SSC Air 10A	TP	✓	✓	✓				
SSC Air 15A	TP	✓	✓	✓				
SSC Boost 10A	TP	✓	✓		✓			
SSC Boost 15A	TP	✓	✓		✓			
Premium SSC Boost 10A	TP	✓	✓		✓	✓	✓	✓
Premium SSC Boost 15A	TP	✓	✓		✓	✓	✓	✓

AS = Air Switch TP = Touch Pad

As the units are limited to the amount of amperage (Amps) they can deliver, not all features can be utilised at the same time.

Portable Spa Pool Systems

Warm jets and relaxing bubbles

Portable Spa pump performance chart

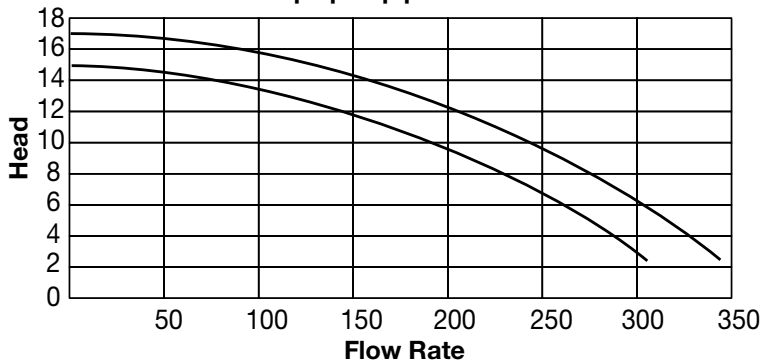

Portapac SSC AIR PANEL Air Mode

(only available on SSC Air models)

This mode activates the pump and a blower. The onboard electronics will run the blower at high speed, medium speed, low speed or in a gentle cycle between high and low speeds to create a massaging effect. If left on for more than 30 minutes, the Portapac will automatically switch to demand mode.

Please note that the above modes can only be run one at a time

Dimension (mm)

Model	Length (mm)	Width (mm)	Height (mm)
Air Switch Models			
Demand, Demand Elite	460	160	265
SSC Touch Pad Models			
SSC Air, SSC Boost, SSC Premium Boost	460	187	250

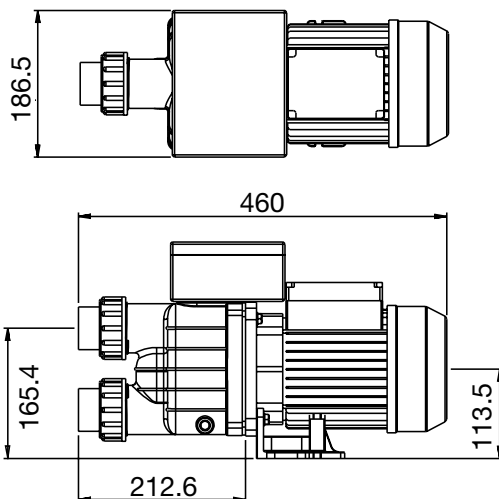

Air Switch

The Air Switch Button is used to cycle through the available modes of the Portapac. The Air Switch Button is sold separately and available in various profiles and colours to suit any décor. A small selection is given below.

Spa Bath Pumps

Compact and efficient hot pumps



Designed to fit underneath the "skirt" of the Spa, the Delta Hot Pump provides an invigorating water massage as well as ensuring the warmth of the water.

- Streamlined compact design.
- Choice of models for most bath sizes.
- Accessories available.
- Flexible unions, Air Switches and Air relief valves supplied as standard.
- Quiet, safe and reliable operation.
- Australian designed and manufactured.
- Complies with Australian / New Zealand Standards AS/ NZS 3136

The Delta Pump is easily activated by a fashionable air switch.



SPA BATH PUMPS

Part Number	Product Description	Nominal Size
2466010	Delta Hot Pump 50 MK2	0.50hp
2466020	Delta Hot Pump 75 MK2	0.75hp

Specifications

Model	Pump		Heater		No. of Jets	Dimensions (mm)			Heat Constant
	Amps	Watts	Amps	Watts		H	W	L	
Delta Hot 50	2.6	620W	6.5	1.6kW	3 - 4	260	185	475	4.4*
Delta Hot 75	3.6	860W	6.5	1.6kW	5 - 6	260	185	475	4.4*

* Based on ideal heating with NO heat loss from the bath

Heat Constant is the time taken to heat 100 litres by 1°C

Time = Heat Constant x spa size in litres x required temp rise / 100

e.g. Time to heat a spa 900lts by 5°C with a Delta Hot 50 or Delta Hot 75

Time = 4.4 x 900 x 5 / 100

= 198 minutes

Note: Actual time to heat may be longer than calculated.

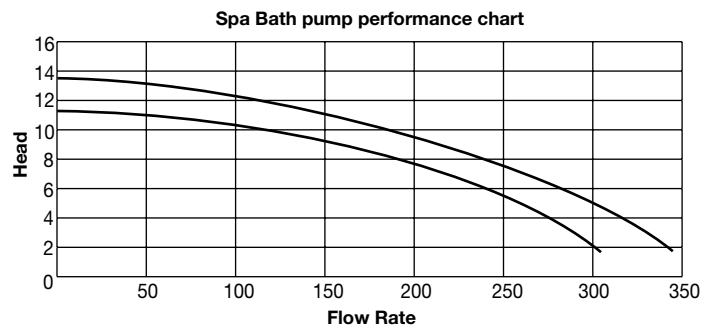

Warranty

Delta Hot Pumps are covered by Waterco's comprehensive 12 month warranty.

Spa Blowers

Whisper quiet performance

SPA BLOWERS

Part Number	Product Description	Nominal Size
282400	Airflo Blower	900W
282401	Whisperair Blower	900W
282421	Whisperair S Blower (c/w airswitch)	900W
282410	Blower Airflo Europe	900W
S13108A	House For Blower	9m

Compact Design

The compact design of the Waterco spa blower enables installation in smaller areas and tight corners. The convenient position of the mounting base and air inlet/outlets reduces installation time and cost.

Thermal Cutout

Waterco spa blowers feature an important safety feature, an integral thermal cutout. This cutout stops the electric motor if it becomes excessively warm. This cutout does not require manual resetting and will automatically restart the motor when it is sufficiently cooled.

- Standard Model – Airflo, Whisperair, Whisperair S



- Inline Model – Whisperair Elite, Whisperair S Elite



- Airswitch Models (Whisperair S and Whisperair S Elite)



- Variable mounts



Enjoy the soothing effects of powerful, invigorating bubbles in your spa without excess equipment noise.

- Whisper quiet operation
- Hi-flow air movement
- Compact design
- Variable mounts

Please note:

It is recommended that the Inline Models be mounted with the Air Inlet Port facing upwards. This will reduce the number of elbows required for the piping.

Technical Specifications

Size	Power	Voltage	Weight	Suction	Flow
225 x 280 x 360	900 Watt	240 AC	3.7kg	50mm hpvc	50mm hpvc

Warranty

Waterco blowers are covered by a comprehensive 12 month warranty.

Electric Heaters

All year round heating



Waterco's electric heaters incorporate the most advanced technology to provide lavish comfort, energy efficient operation and long lasting dependability.

Each heater is complete with its own safety and control devices, and requires no other controls for safe operation.

ELECTRIC HEATERS

Part Number	Product Description	Nominal Size
28006	Waterco Single Phase Heater	6kW
28118	Waterco 3 Phase Heater	18kW
28124	Waterco 3 Phase Heater	24kW

18kW & 24kW	6kW
Three phase Body : 316 grade Stainless Steel	Single phase Body : Engineering Plastic

- Incoloy heater element - nickel-chromium alloy with good strength and excellent corrosion resistance.
- Manual reset high-limit switch
- Pressure switch to prevent operation without water flow
- High limit temperature control to prevent overheating
- Dependable high quality thermostat
- 40mm and 50mm quick connect unions

All heaters are approved to AS3136 for use throughout Australia and New Zealand as a prescribed Electrical Article, and carry the appropriate approval number.

Technical Data

Thermostat temperature adjustment	: 20 deg C - 40 deg C
Over-temperature sensor	: 45 deg C
Maximum temperature	: 70 deg C
Pressure switch settings	: On 35 kPa (3.5m head)
	: Off 15 kPa (1.5m head)
Maximum working pressure	: 250 kPa
Maximum pressure	: 350 kPa
International protection rating	: IP23
Amps - 6kW	: 25 amps
Amps per phase - 18kW	: 25 amps
Amps per phase - 24kW	: 34 amps

Single Phase (6kW)

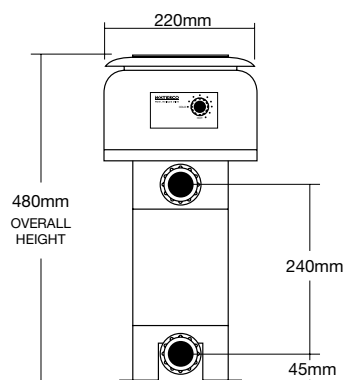

Three Phase (18kW & 24kW)

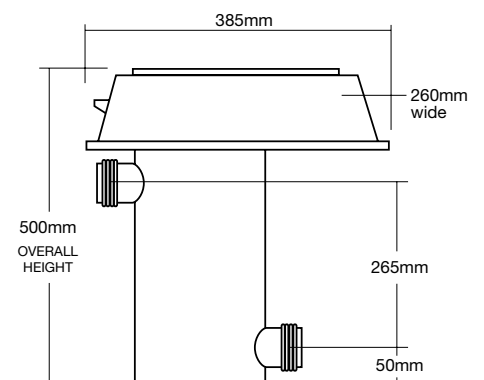

Spa Filtration / Accessories

SPA FILTRATION

Part Number	Product Description	Nominal Size
4555250	Top Load Filter 50 sq ft	40mm Connectors
4555275	Top Load Filter 75 sq ft	40mm Connectors
AFI060	Top Load Niche and Lid - White	
AFI066	Top Load Niche Lid (only) - Grey	
AFI063	Top Load Niche and Lid - Black	
AFI062	Top Load Filter Base	
62010	Top Load Filter Cartridge 50 sq ft	
62009	Top Load Filter Cartridge 75 sq ft	

Specifications

Model	Filter Area (Sq m)	Max Flow (³/hr)	Working Pressure	Max Temp
C50	4.6	11.4	250kPa / 36psi	40°C
C75	6.9	16.5	250kPa / 36psi	40°C



CONCRETE SPA JETS

Part Number	Product Description	Nominal Size
45530	Concrete Spa Jets comprises:-	40mm
45365	1 x Venturi "T" with 25mm pipe	40mm
29101	1 x Eyeball to suit - white	CL9/40mm
453653	Venturi Nozzle (only)	
ASF170	Self Set Air Control - White	25mm
ASF174	Self Set Air Control - Beige	25mm
ASF199	Self Set Air Control - White	40mm
ASF201	Self Set Air Control - Beige	40mm
ASF242	Air Injector - White	
ASF243	Air Injector - Beige	
ASF396	Extended Venturi Jet - White c/w white pool return	
ASF400	Extended Venturi Jet - Beige c/w beige pool return	



AIR SWITCH CONTROLS (w/o Buttons)

Part Number	Product Description	Nominal Size
ASF010	Single Air Switch c/w Tubing	
ASF012	Single Air Switch c/w Time Clock and Tubing	
ASF024	Double Air Switch c/w Tubing	
ASF026	Double Air Switch c/w Time Clock and Tubing	
82441901	Air Tube 3mm x 6m (For Senex Blower & Air Switch)	



Spa Accessories

INGROUND / PORTABLE SPA AIR SYSTEM COMPONENTS

Part Number	Product Description	Nominal Size
ASP215	S & P Air Injector White (Top, Body & Clamp)	
ASP217	S & P Air Injector Grey (Top, Body & Clamp)	
AC1776	Air Injector Body Only	
AC1434	S & P Injector Top Only White	
AC1777	Aus Stream Top Only White	
AC2028	S & P Injector Top Only Grey	
AC643	Manifold Section 3 barb x 9mm	
AC655	Reducing bush air injector black	
AC1045	Stop end Air Injector black	

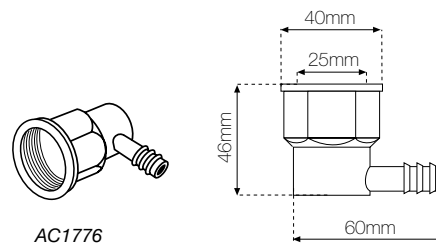

AC1776

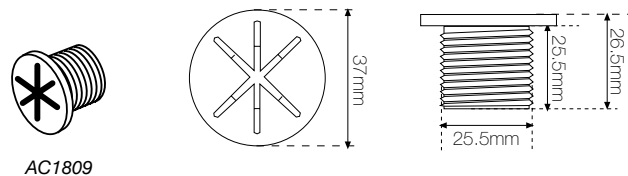

AC1809

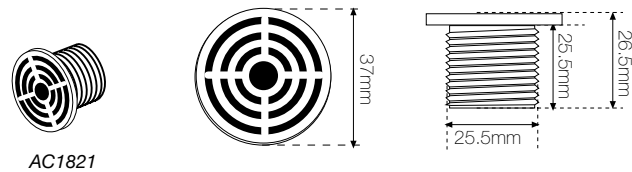

AC1821

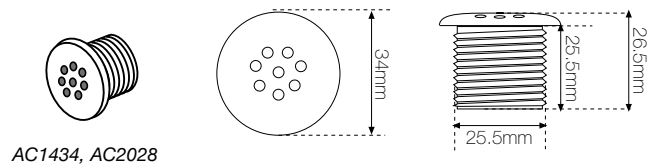

AC1434, AC2028

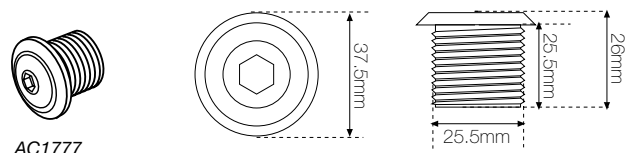

AC1777

Spa Accessories

WATERCO AIR BUTTON S&P

Part Number	Product Description	Nominal Size
ASF202	Air Button Low Profile - White (Other colours available)	
ASF218	Air Button Low Profile - Chrome A.B.S	

WATERCO

455102	Flush Air Button - White	
ASF242	Air Injector - White	
ASF243	Air Injector - Beige	

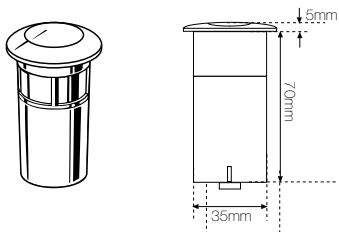

ASF202, ASF218, ASF219, ASF220, ASF222

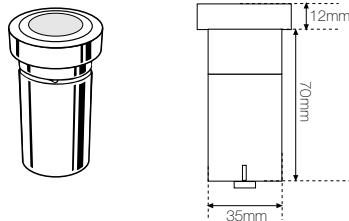

ASF224, AS&P083, AS&P084



AIR CONTROLS S&P

Part Number	Product Description	Nominal Size
ASF102	Standard Air Control - White (Other colours available)	

WATERCO

455302	Silent Air Control - White	
45242	Air Bleed Valve - White	25mm

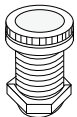

ASF102, ASF124,
ASF126,
ASF196, ASF198

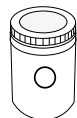
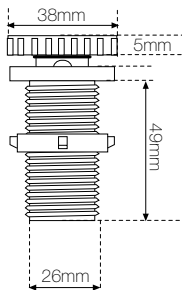

ASF150, ASF164,
ASF166

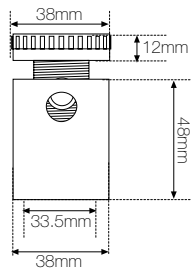

AZPV100

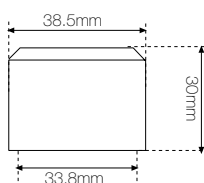

ASP081

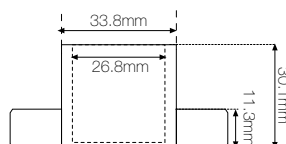

Spa Accessories

TURBO JETS

Part Number	Product Description	Nominal Size
AS&P399	Adjustable Turbo Jets Complete (19mm x 9mm) Barbed Body	
ASF440	Adjustable Turbo Jets Complete	
ASP210	Turbo Jet Grey 40mm	

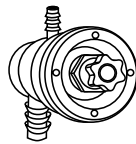

AS&P399

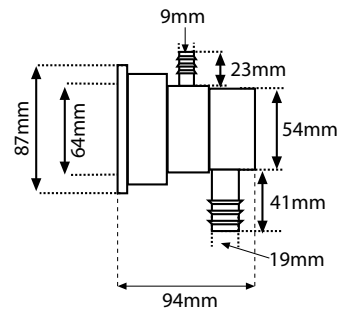

37LMP 10 US GPM @ 104KPA - 15PSI

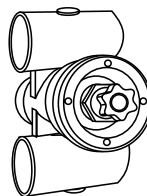

ASF440

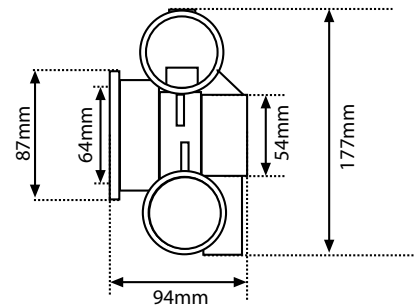

37LMP 10 US GPM @ 104KPA - 15PSI

TURBO ESCUTCHEONS

Part Number	Product Description	Nominal Size
ASP550	White Turbo Escutcheon	



ASP550, ASP552, ASP556

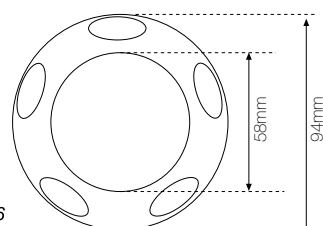

Spa Accessories

SPA SUCTION FITTINGS AND SKIMMERS S&P

Part Number	Product Description	Nominal Size
ASP211	Slip Suction - Grey	
ASF480	Supa Suction 40mm - White (Other colours avail.)	

ASF508, ASF528,
ASF529, ASF506, ASF507

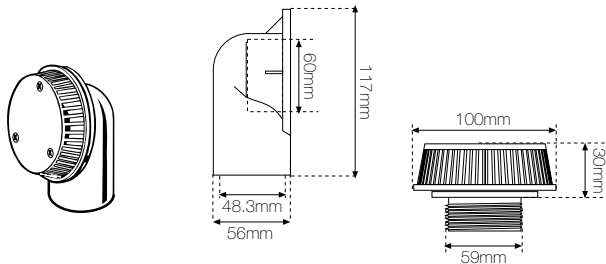

ASF480, ASF510,
ASF512, ASF514, ASF518

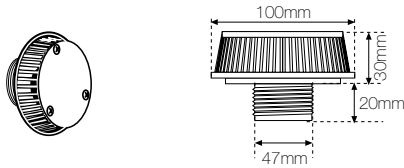

SPA SUCTION FITTINGS AND SKIMMERS - CONTINUED S&P

Part Number	Product Description	Nominal Size
ASF080	Strip Skimmer - White*	

ASF523, ASF574,
ASF576, ASF567, ASF568

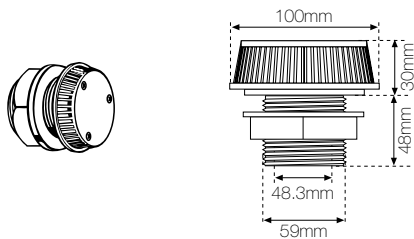

ASF080, ASF096

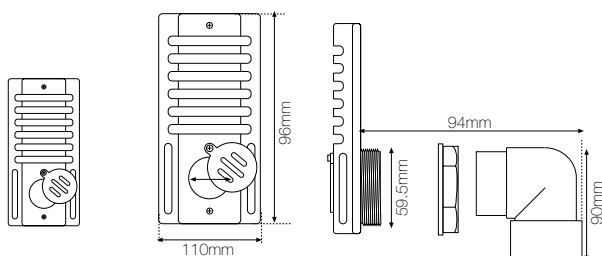

Spa Accessories

REGENCY

Part Number	Product Description	Nominal Size
ASP566	Regency Slip Suction - White*	



ASP551, ASP553

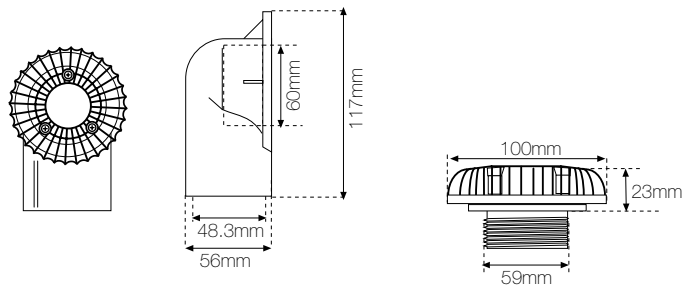

ASP566, ASP560, ASP562

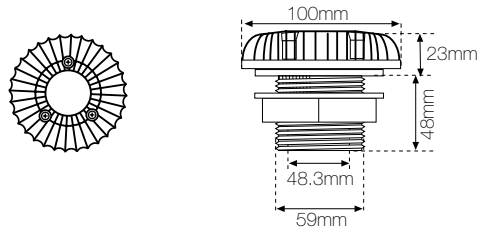

FLEXI HOSE AND CLAMPS

Part Number	Product Description	Nominal Size
AZSF952	20m x 9mm White Hose	
AS&P242	100m x 9mm Clear Hose	
AS&P412	30m x 19mm Clear Hose	
AC1785	Hose Clamp 9mm	
AC1796	Hose Clamp 19mm	
ASP083	Hose Clip 25mm x 9mm	



PVC Flexible Tubing



AS&P242, AS&P412, AZP952

AS&P242
For 9mm - 3/8" barbs.
3mm - 1/8" wall thickness
100m - 332' roll length



AS&P412
For 19mm - 3/4" barbs.
3mm - 1/8" wall thickness
10m - 33' roll length

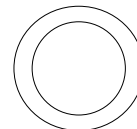

AZP952
For 9mm - 3/8" barbs.
For air injectors
2mm - 1/16" wall thickness
30m - 99' roll length



Hose Clamp for Flexible Hose



AC1785, AC1796

Ratchet clamps for flexi hose. Simply push end together.
AC1785
Ratchet clamp for AS&P242 hose.
AC1796
Ratchet clamp for AS&P412 hose.

Hose and Pipe Clip



ASP083

A hose for 25mm - 1" nominal pipe and 9mm - 3/8" flexi hose for use with the ASP508 Tee mini body. Keeps the airline retained for self draining.

Spa Accessories

SPECIALTY SPA FITTINGS S&P

Part Number	Product Description	Nominal Size
ASF274	Ultra Pool Return	
AC580	Flanged Faucet Elbow 40mm	
ASF602	Flanged Faucet Socket 40mm	
ASF612	Spa Tee 40mm x 25mm x 25mm	
AC700	Internal End Cap 25mm	
AC703	Internal End Cap 40mm	
AZPV100	Threaded Cap 25mm	
AC1787	Clear Grommet	



ASF274

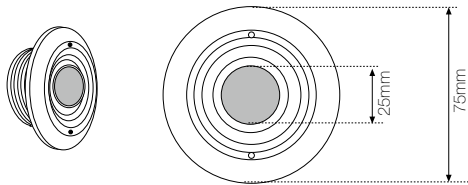

ASF274

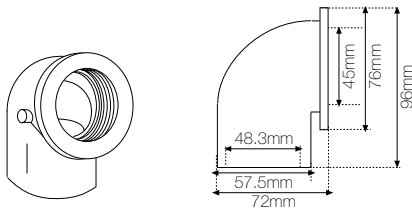

ASF274

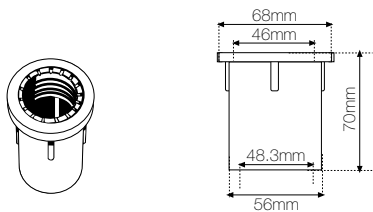

ASF274

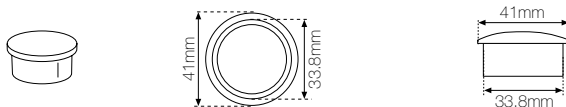

ASF274

